

VALUATION OF REACTIVE POWER ZONAL CAPACITY PAYMENTS

Pablo Frías, David Soler and Tomás Gómez
Instituto de Investigación Tecnológica of Universidad Pontificia Comillas
Madrid, Spain
pablo.frias@iit.upco.es, soneira@upco.es, tomas.gomez@iit.upco.es

Abstract – This paper presents a new approach to design long-term zonal reactive power capacity markets. Under this approach, in each voltage control area, an annual auction to procure reactive power capacity is conducted by the System Operator. A key contribution of the paper is the method to compute the zonal demand curve using the marginal utility function. This function is calculated as the variation of the expected operation costs when the reactive power capacity in the area is increased. The applicability of the approach is illustrated in a case study with one voltage control area.

Keywords: ancillary services, open access, reactive power valuation, voltage support, utility function, capacity payments

1 INTRODUCTION

Nowadays, international electric regulation stresses the role of competitive markets for the procurement and remuneration of ancillary services, among which stands the reactive power and voltage control service in transmission networks. Reactive power management has three time-frame levels: (i) dynamic voltage regulation, controlling instantaneous bus voltage changes using fast regulating devices; (ii) reactive power dispatching, where the System Operator supervises hourly reactive power procurement in front of system demand and network topology changes; and (iii) reactive capacity planning, where the System Operator guarantees that there is enough reactive power capacity installed to maintain system voltage security for the near future. This paper is focused on long-term reactive capacity procurement, and assumes that short-term reactive power dispatch is somehow remunerated.

There have been many approaches to manage the procurement and payment for the reactive power and voltage control service. Between them, maybe the most popular is the one based on long-term reactive power capacity contracts made between the System Operator and the selected generators. In most of these cases the contract is based on a regulated payment for the service fixed by the System Operator. These regulated payments are often too simplistic and do not capture the local characteristics of the different reactive power sources. Other approaches to procure and remunerate this service are based on short-term economic signals like reactive spot pricing [1-2], or based on the computation, also in the short-term, of the contribution to the system security made by each reactive power source [3]. Under these approaches is difficult to implement a potential market

to provide the service because generators have market power while offering reactive power provision in the short term. Therefore, there is a need to develop a new approach to procure and to remunerate reactive power services providing a proper compensation for each reactive source, and maximizing system security and efficiency.

This paper proposes a competitive mechanism for reactive power provision, based on a long-term capacity market for each voltage control area, with an annual auction. The principles of this market are similar to the ones that have been proposed in [4] to establish capacity payments in wholesale energy markets. First, the two market products to be negotiated are identified: (i) capacity for reactive power generation, and (ii) capacity for reactive power absorption. Then, the market mechanism based on an annual auction where reactive capacity bids from existing and new sources are matched with the reactive demand curve, previously obtained by the System Operator, is described. Section 2 presents the proposed organization for these zonal reactive capacity markets.

An important contribution of the paper is the method to calculate the zonal demand curve using the marginal utility function. This function is calculated as the variation of the expected operation costs when the reactive power capacity in the area is increased. Section 3 defines the utility function, and provides a mathematical approach to build the demand curve for the reactive power capacity service.

Finally, in Section 4, a small case study with one single voltage control area is used to demonstrate the applicability of the approach, where prices and volumes for regulating capacity are calculated for each reactive power source.

2 ORGANIZATION OF THE REACTIVE POWER CAPACITY MARKET

This section presents the proposed zonal reactive capacity market organization in detail. The local nature of reactive power and voltage control and therefore the need for organizing different zonal markets are firstly discussed. Then, market products and supply and demand curves are characterized. Finally, the mechanism for market settlement is described.

Due to the local nature of the reactive power, one single market for reactive capacity in the system is not feasible. Even in local reactive markets some generators may exercise market power if they are the only way to

control voltages in a particular area. However, as investment in new reactive power devices are smaller and construction periods are shorter than that for active power devices, the reactive power market design should allow the entrance of new agents building new installations if they are required. That is the reason to propose long-term zonal capacity markets.

In a reactive capacity market two basic products can be defined: (i) reactive power generation capacity, and (ii) reactive power absorption capacity. Both products are required to be available all day long in the electric system operation. Nevertheless reactive power generation is mainly needed in high demand hours and reactive power absorption in low demand hours, due to load and system characteristics. These two products should be supplied by the reactive sources that have been selected in the corresponding auction. This implies an obligation to provide the assigned firm reactive capacity during the required period, existing an explicit penalty in case of non-delivery.

2.1 Voltage control areas

Any power system can be separated into different voltage control areas. Each area comprises a set of buses sufficiently electrically coupled, and reasonably electrically decoupled from the rest. To avoid voltage control interference control areas should not be overlapped, so voltages in one area are mainly controlled by reactive sources located in that area, considering as negligible the influence from reactive devices in other areas. Multiple methods have been developed to identify voltage control areas, most of them use the concept of electrical distance to classify the buses in the system [5-7].

Zonal reactive power capacity markets based on different voltage control areas have many advantages [8]:

- Areas with low price bids set a lower market price for reactive power than that of higher price bids. So an area localization signal is sent to the investors to add new reactive power devices to areas with higher reactive market price.
- Generator price gaming in one area will not affect other areas market prices.

Due to the fact that reactive sources inside the same area have similar effects on the area voltage control, the reactive capacity in the area is the uniform product that can be traded in the corresponding zonal market. That reactive capacity should be differentiated in reactive power generation and reactive power absorption. These two products can be delivered by generators and different static devices, such as reactors, capacitor banks, SVC's, etc.

2.2 Reactive power supply bids

Any reactive power device located in a voltage control area can bid in the corresponding zonal reactive generation and reactive absorption capacity markets. Supply bids should include a pair of price and quantity values. The price represents the minimum annual

revenue that the generator is willing to receive for the submitted quantity amount. Several bids for different blocks of reactive capacity submitted by the same installation are also allowed.

Bids should internalise reactive power costs, which are mainly investment costs for new reactive power sources and upgrading for the existing ones. In addition other operating costs should be included in the bid price, such as internal active power losses and maintenance costs.

On the other hand, reactive sources should also internalise, in the bid price, the probability to incur in a penalty if the reactive power capacity assigned in the market is not available when the System Operator requires for it. This availability is modelled with the failure per year rate (λ).

Reactive power devices differ greatly in their voltage control characteristics. There are mainly two voltage control systems: (i) continuous voltage control by generators and SVC's, and (ii) stepping control by capacitor banks, reactors, and transformers. Generators and SVC's perform the instantaneous voltage control, while stepping devices runs a control with a higher time constant. A fairly voltage control would have only continuous devices as generators, but using stepping devices can substitute generators capacity. Anyway it is desirable to use a mix of continuous and stepping devices to control voltages in any area. In this paper there is not any specific proposal in this matter, but future work will deal with it.

2.3 Reactive capacity demand

The System Operator, taking into account operational costs and specific characteristics of each particular voltage control area, will construct a demand curve following the methodology presented in Section 3 of this paper.

2.4 Market settlement

The reactive power capacity provision is arranged through long-term contracts between the System Operator and the market selected supply agents. Reactive capacity contracts are awarded in an annual auction for each voltage control area. For example, this auction could be called every year looking for the reactive capacity requirements non-covered by contracts and needed for the following year, that is, one year in advance to allow new investment entrance. Contracts are extended to a larger period, for instance, four years, to provide a stable economic signal for investments.

The mechanism suggested for the reactive power capacity auction would have the following sequence:

- The System Operator determines the reactive power capacity needs and already non-covered by contracts for each area.
- The System Operator builds the demand curve for reactive power generation capacity and absorption capacity (see Section 3).

- Reactive power devices submit supply bids in quantity and price, for both reactive generation and absorption capacity.
- Bids are ordered according to their price.
- The demand curve for generation capacity is matched with the ordered bids for this product, and a volume and price for reactive power generation capacity is obtained. The same applies to reactive power absorption.
- All agents offering below the market price will be awarded with a contract at the market price. Assigned reactive capacity must provide for every hour in the time horizon of the contract the assigned reactive power for generation or absorption. If any device does not provide the reactive power when required, an explicit penalization to that unit would be applied.

The entrance of new agents in the reactive power capacity market sets the cap price, so capacity bids cannot be higher than investment costs for reactors and capacitor banks in generation and absorption capacity markets respectively.

3 DEMAND CURVE FOR REACTIVE POWER CAPACITY

This section presents a method to calculate the demand side curve for the reactive power capacity market, using the concept of utility function. The utility function in this case is defined as the variation of the system operation costs when then amount of reactive power capacity in the area is changed. First, total operational costs for a specific scenario are calculated as the sum of different cost concepts. Then, simulation is carried out to consider multiple scenarios with system contingencies. Finally, the expected operation costs are computed using the probability of occurrence for each scenario. The utility function is then built by computing total expected operational costs for different reactive capacity available in the area. The derivative of the utility function is the marginal utility function, and represents the demand side curve for the reactive power capacity market.

3.1 System operation costs for a scenario

The utility function is defined as the change in the system operation costs, in each voltage control area, when capacity for reactive power generation or absorption is increased in the area. The system operation costs include four different system concept costs: security, voltage quality, energy losses, and redispatching costs.

When there is not enough reactive power capacity in an area to maintain acceptable voltages, security of supply risks. In this case, load shedding would be needed to keep a pre-specified security margin to the voltage collapse point. Under this situation non-supplied energy costs will arise. The cost associated with non-supplied power (C_s) can be calculated as the product of

non-supplied power amount (NSP) times the penalty price in €/kWh (p^{NSP}):

$$C_s = p^{NSP} \cdot NSP \quad (1)$$

System operation procedures set a security margin for voltage deviations in all the buses specifying a maximum (V_i^{\max}) and a minimum (V_i^{\min}) voltage values. Besides, reference voltage values (V_i^{ref}) for every bus that optimize system operation are periodically set by the System Operator. Therefore, voltage quality costs (C_q) can be obtained in each voltage control area (A) as the product of a price penalty (p_i^V) times the power supplied in the corresponding bus (P_i). The price penalty function consists of a bathtub curve (Figure 1), where voltage deviations from reference values are penalised if voltage reference limits ($V_i^{\min,ref}$, $V_i^{\max,ref}$) are violated.

$$p_i^V = f(V_i - V_i^{ref}, V_i^{\max,ref}, V_i^{\max}) \cdot \theta_i + f(V_i - V_i^{ref}, V_i^{\min,ref}, V_i^{\min}) \cdot (1 - \theta_i) \quad (2)$$

$$V_i \geq V_i^{\max,ref} \rightarrow \theta_i = 1, \quad V_i < V_i^{\min,ref} \rightarrow \theta_i = 0$$

$$C_q = \sum_{i \in A} p_i^V \cdot P_i \quad (3)$$

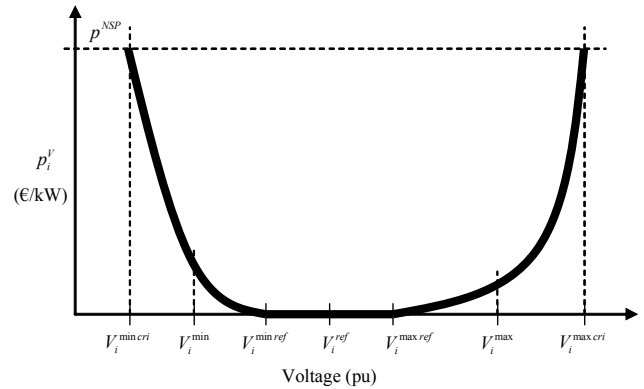

Figure 1: Bath tub curve to calculate the penalty factor

Voltage control can help to reduce active energy losses as high voltages reduce branch currents. The energy losses costs (C_l) can be calculated as the product of the energy price (p^p) times the active power losses in the transmission system. Branch losses are calculated as the product of the line resistance (r_l) times the square branch current (I_l):

$$C_l = p^p \cdot \sum_{l \in A} f(r_l \cdot I_l^2) \quad (4)$$

When the System Operator redispatches a generator to solve voltage problems in the specific area because there are not more reactive sources available, this unit is usually paid for this service at its bid price p^r . Then redispatching costs (C_r) are calculated as the product of

redispatching price times the active power change (ΔP_g).

$$C_r = \sum_{g \in A} p^r \cdot \Delta P_g \quad (5)$$

Finally, total operation costs in a voltage control area for a specific power system scenario n with time duration t_n are computed as:

$$C_{T,n} = t_n (C_s + C_q + C_l + C_r) \quad (6)$$

3.2 Expected system operation costs

Once the method to compute the operation costs for a single scenario has been presented, it is needed to develop a methodology to combine multiple scenarios to take into account contingency situations where reactive capacity is more needed. Under this assumption, to obtain the expected operation costs, a multi-scenario simulation is carried out using a Monte Carlo technique [9].

Each scenario is defined by: (i) technical and operating data, and (ii) a specific value for each random variable represented by a probability distribution function. Technical and operating data include the following:

- **Network topology:** branches and buses.
- **Lines:** impedances and power rating.
- **Generators and reactive power devices:** reactive power capability curve, and active power generation in high and low demand hours.
- **Loads:** demand for high and low demand hours; this data can be obtained from databases from the System Operator.

Probabilistic parameters include failure rates for lines, generators and reactive devices, and dispatching probability at high and low demand hours for generators.

A Monte Carlo simulation [10] is carried out to obtain random numbers for the probability distributions of failure rates. Each set of random numbers defines a different scenario, characterized by:

- Network topology.
- Status of lines, generators and other devices.
- Generator dispatch and load demand.

Reactive power requirements are mainly stressed in peak hours when reactive generation is needed, and low demand hours when reactive absorption must reduce voltage levels. Then, to determine the demand curve for reactive generation capacity scenarios representing high demand hours are considered, while for reactive absorption capacity scenarios for low demand hours are simulated.

Simulations are carried out for different levels of reactive power generation and absorption capacities in the studied area. Total operation costs are computed for several scenarios representing probable operation cases.

Once a set of scenarios N have been simulated the expected costs can be calculated as the sample mean [11]:

$$EC_n = \frac{\sum C_{T,n}}{N} \quad (7)$$

Because operational costs increase significantly when system contingencies happen, the Conditional Monte Carlo method [12] has been used in order to reduce the sample variance. Then, the new formulation for the expected costs is presented in equation (8), where scenarios are classified into two sets: (i) n_w scenarios without contingencies, and (ii) n_c scenarios with contingencies (where R is the set of system components with a failure rate different from zero).

$$EC_n = \frac{\sum_{n=1}^{n_w} C_{T,n}}{N_w} \cdot \prod_{r=1}^R (1 - \lambda_r) + \frac{\sum_{n=n_w+1}^{n_w+n_c} C_{T,n}}{N_c} \left(1 - \prod_{r=1}^R (1 - \lambda_r) \right) \quad (8)$$

3.3 The marginal utility function

To build the utility function a systematic procedure is followed. Each value of this function is computed by setting a total amount of reactive capacity available in the particular voltage control area, and with the method presented in the previous section, calculating the corresponding expected operation costs. This process is repeated for different reactive capacity amounts. Figure 2 represents two utility functions; one corresponds to reactive generation capacity, and the other one to reactive absorption capacity.

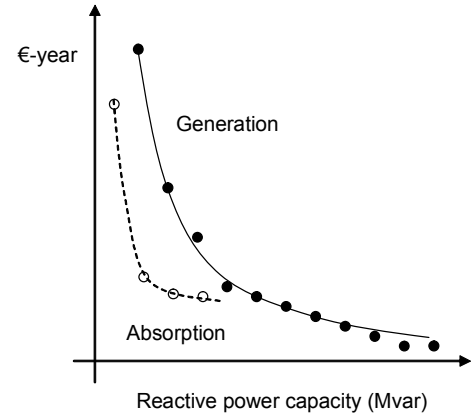

Figure 2: Total expected cost for reactive power generation and absorption capacities

Once the utility function is numerically computed, a mathematical equation is obtained for this function by using least squares fitting. The derivative of the utility function is the marginal utility function. This function represents the market demand curve, i.e., the reduction in the expected operation costs if a unitary increment in

the reactive power capacity in the area could be available (Figure 3).

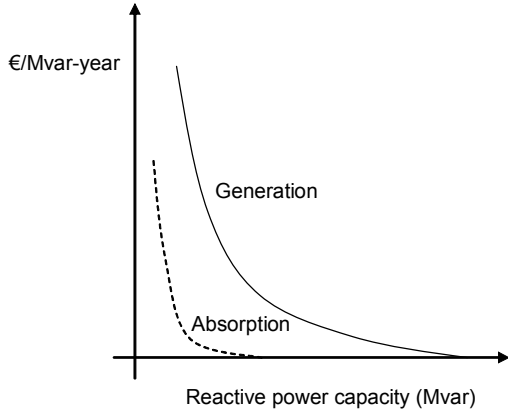

Figure 3: Market demand side curves for reactive power generation and absorption capacities

4 CASE STUDY

The reactive market approach presented in this paper is illustrated with a small single area case study (see Figure 4). The system has three generators: nuclear, hydro and fuel. Load is connected at bus 3, and the rest of the power system is modelled with an equivalent generator in bus 4.

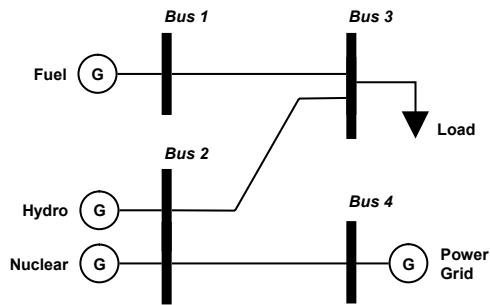

Figure 4: Case study

Table 1 includes voltage reference value and limits.

V^{ref} (pu)	V^{MIN_ref} (pu)	V^{MAX_ref} (pu)	V^{MIN} (pu)	V^{MAX} (pu)
1	0.975	1.025	0.95	1.087

Table 1: Bus reference values and limits

Table 2 presents generator parameters. Parameter η represents the generator probability of being dispatched in high and low demand hours respectively.

Bus	Type	P (MW)		Q_{max} (Mvar)		η (pu)		λ (€/year)
		High load	Low load	Gen.	Abs.	High load	Low load	
1	Fuel	30	0	10	5	0.8	0.1	1.1
2	Hydro	50	10	30	15	0.9	0.5	0.4
2	Nuclear	100	100	60	30	1.0	1.0	0.2

Table 2: Generator technical and operational parameters

Table 3 presents transmission line parameters.

From	To	P_{limit} (MW)	R_l (pu)	X_l (pu)	B_l (pu)	λ (€/year)
1	3	100	0.0012	0.013	0.135	0.02
2	3	150	0.0023	0.022	0.211	0.04
2	4	150	0.0042	0.041	0.51	0.08

Table 3: Transmission lines technical parameters

Table 4 presents load parameters. Demand in peak and valley hours is expressed as a percentage of the nominal load.

Bus	P_n (MW)	Q_n (Mvar)	High (%)	Low (%)
3	110	70	100	50

Table 4: Load parameters

Table 5 presents energy prices to value energy losses and penalty prices to value non-supplied power.

	p^P (c€/kWh)	p^{NSP} (c€/kWh)
High	4	1000
Low	2	100

Table 5: Economic parameters

The Monte Carlo Simulation has been run for 200 scenarios without contingencies and 1.000 scenarios with contingencies, for high demand hours; and the same number of scenarios for low demand hours. The results for the total expected costs for reactive power generation capacity are shown in Figure 5. In this figure can be observed if the available reactive generation capacity exceeds the amount of 30Mvar the corresponding expected costs are kept in a low value associated mainly to energy losses. If available reactive capacity decreases below that value, then expected costs increase as voltage quality penalties and non-supplied energy rise.

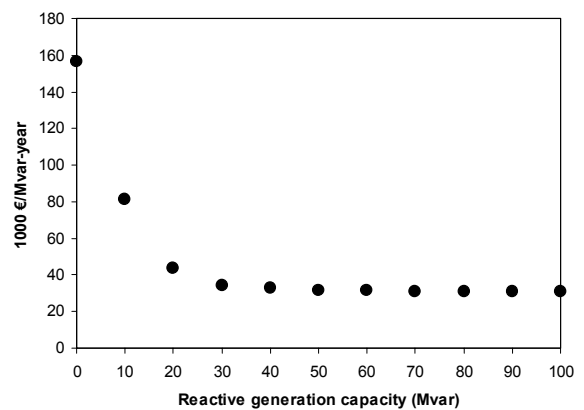

Figure 5: Total expected costs for reactive power generation capacity

The derivative of the utility function which represents the reactive market demand curve is shown in Figure 6.

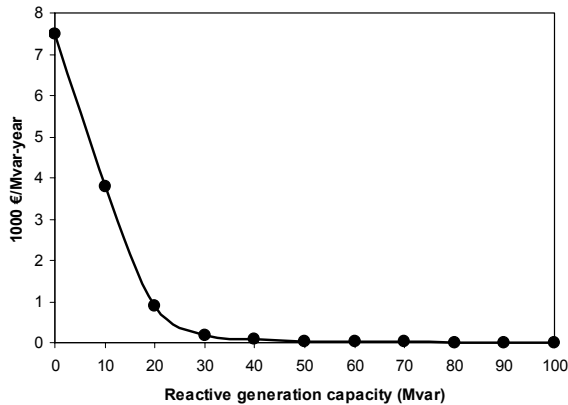

Figure 6: Demand curve for reactive power generation capacity

Generator bids, the obtained reactive demand and the market clearing point are shown in Figure 7 for reactive generation capacity, and in Figure 8 for reactive absorption capacity.

For illustrative purposes, the reactive power capacity bid made by the nuclear generator has been divided into two capacity blocks, while hydro and fuel generator bids are one block bids. On the other hand, generator bids for reactive generation capacity have been modeled at a higher price than for absorption capacity.

The resulting market price for reactive generation capacity at 900€/Mvar-year (see Figure 7) will provide the economic signal to new potential sources to be installed in the system. For instance, a capacitor bank with an estimated investment cost of 6.000 €/Mvar, would recover that costs in almost 7 years.

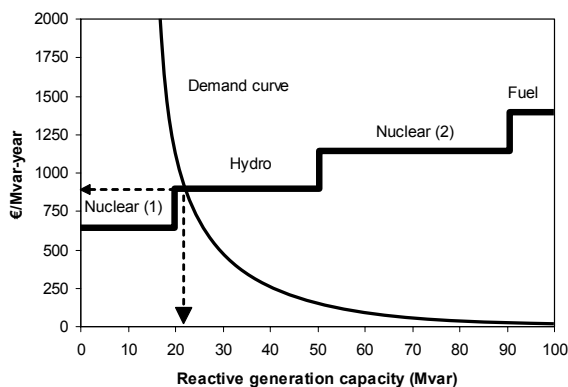

Figure 7: Market clearing for reactive power generation capacity

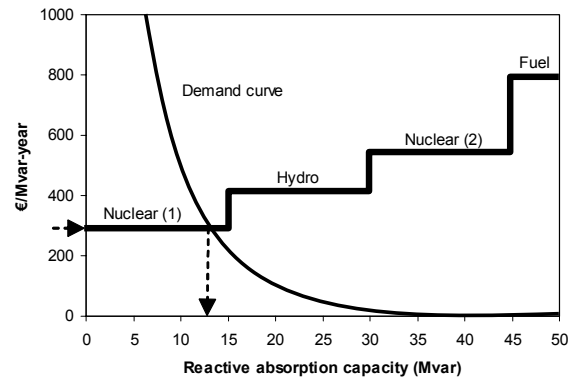

Figure 8: Market clearing for reactive power absorption capacity

5 CONCLUSIONS

This paper has presented a new approach to design long-term reactive power capacity markets. The market design is based on a competitive market auction which is run in every year by the System Operator.

In each voltage control area, this annual auction selects the reactive capacity supply bids which are lower price to match the reactive capacity demand curve that has been calculated by the System Operator.

A new methodology has been presented to compute the reactive market demand curve as a marginal utility function, where total operational costs are decomposed in different cost concepts associated to voltage security and quality, energy losses and generator redispatching to solve voltage operational constraints.

The main issues concerning the proposed market organization has been analyzed in this paper. Future work is needed to progress in the definition of implementation details in order to achieve a practical solution for the real world. New research will be focused on the following subjects:

- Relationship between the proposed reactive capacity market and congestion management mechanisms that redispatch generators to alleviate voltage problems.
- Modelling of the technical differences between reactive sources regulating capabilities inside a voltage control area.
- Investigate generator bidding strategies taking into account their own technical and economical characteristics.

REFERENCES

- [1] J. Barquín, T. Gómez, J.J. Alba, and P. Sánchez, "Reactive power pricing: a conceptual framework for remuneration and charging procedures", *IEEE Transactions on Power Systems*, 2000, vol. 15, no. 2, pp. 483–489
- [2] M.L. Baughman, S.N. Siddiqi, and J.W. Zarnikau, "Advanced pricing in electrical systems. Part I: theory", *IEEE Transactions on Power Systems*, 1997, vol. 12, no. 1, pp. 489–495

- [3] W. Xu, Y. Zhang, L.C.P. da Silva, P. Kundur, and A.A. Warrack “Valuation of dynamic reactive power support services for transmission access”, IEEE Transactions on Power Systems, 2001, vol. 16, no. 4, pp. 719–28
- [4] C. Vazquez, M. Rivier, and I.J. Pérez-Arriaga, “A market approach to long-term security of supply”, IEEE Transactions on Power Systems, 2002, vol. 17, no. 2, pp. 349–357
- [5] P. Lagonotte, J.C. Sabonnadiere, J.Y. Leost, and J.P. Paul, “Structural analysis of the electrical system: application to secondary voltage control in France”, IEEE Transactions on Power Systems, 1989, vol. 4, pp. 479–486
- [6] A. Conejo, T. Gómez, and J.I. de la Fuente, “Pilot bus selection for secondary voltage control”, European Transactions on Electrical Power Engineering, ETEP, 1993, vol. 3, No. 9, pp. 359-366.
- [7] J. Barquín, T. Gómez, and F.L. Pagola, “Estimating the loading limit margin taking into account voltage collapse areas”, IEEE Transactions on Power Systems, 1995, vol. 10, pp. 1952–1962
- [8] J. Zhong, E. Nobile, A. Bose, and K. Bhattacharya, “Localized reactive power markets using the concept of voltage control areas”, IEEE Transactions on Power Systems, 2004, vol. 19, no. 3, pp. 1555–1561
- [9] R. Billinton and W. Li, “Reliability assessment of Electric Power Systems using Monte Carlo methods”, Plenum Press, New York, 1994.
- [10] P. Bratley and L.E. Schrape, “A guide to simulation”, 2nd edition Springer-Verlag, 1987.
- [11] V. Neumann, “Various techniques used in connection with random digits”, National Bureau of Standards Applied Mathematics, Series 12, 1951.
- [12] M.A. Law and D. Kelton, “Simulation modelling and analysis”. 2nd Edition, 2000, McGraw-Hill International Editions. Industrial Engineering Series.